

BRODA[®] SEATING

OPERATING INSTRUCTIONS

Basic Models:

30VT Semi-Recliner

80V Tilt Chair



Broda Seating
385 Phillip St. Waterloo, ON Canada N2L 5R8
Phone Toll Free Can/US. 1-(800) 668-0637 Fax: (519) 746-8616
www.brodaseating.com
sales@brodaseating.com

Instructions for Use

Foreword	1
General Instructions	2
1.0 SAFETY INSTRUCTIONS	3
1.1 Before First Use	3
1.2 Application	3
1.3 Legal Restrictions	4
1.4 Position of Chair “Danger of Falling”	4
1.5 Position of Seat Tilt “Danger of Tipping”	4
1.6 Location of Chair “Danger of Tipping or Falling Objects”	4
1.7 Total Lock Wheel Brakes “Danger of Falling”	4
1.8 Re-Positioning of Resident “Danger of Clamping”	5
1.9 Unintended Movement “Danger of Falling or Collision”	5
1.10 Resident Clothing “Risk of Injury to Resident’s Skin”	5
1.11 Improper Restraint Use “Risk of Serious Injury”	5
1.12 Improper Use	6
1.13 Cleaning	6
1.14 Preventative Maintenance	6
1.15 Resident Specific Instructions	7
2.0 DEFINITIONS and TECHNICAL INFORMATION	7
2.1 Definitions	7
2.2 Technical Information	7
2.3 Shipping and Storage Specifications	8
2.4 Labels	9
3.0 CAREGIVER MANAGEMENT	10
4.0 OPERATION and MOVEMENT	11
4.1 Seat Tilt	11
4.2 Back Recline	11
4.3 Elevating Leg Rest	12
4.4 Flip Down Footrest	12
4.5 Removable Wings	14
4.6 Shoulder Bolsters	14
4.7 Height Adjustable Armrests	15
4.8 Adjustable Seat Height	15
4.9 Casters	15
4.10 Accessories	16
4.11 Broda Tray	16
4.12 Broda Thigh Belt	16
4.13 Broda HSP Padding Package	17
5.0 INSPECTION and FUNCTIONAL TESTING	17
5.1 Inspection	17
5.2 Functional Testing	18
6.0 RESIDENT SPECIFIC INSTRUCTIONS (Additions to Section 1)	19
7.0 REPAIR AND MAINTENANCE	
7.1 Trouble Shooting for Cylinders	20
7.2 Cables and Handles	21
7.3 Vinyl Strapping	23
8.0 WARRANTY INFORMATION	25



Foreword

Congratulations on your purchase of a BRODA chair and thank you for your confidence in our company and our products.

BRODA Seating has assumed a leadership position in providing the optimum in re-positioning functions and mobility for residents of long term care institutions. BRODA chairs do not look like traditional chairs and offer unique advantages found only with a BRODA. We are sure that after learning about BRODA, you will be convinced that your residents' quality of life will be greatly enhanced by BRODA chairs.

BRODA's products were designed to be recommended by Professional Caregivers for residents who require long term care. The maximum benefit to the resident using this chair will be achieved with the advice and assistance of their Caregivers.

This manual will assist you in making the best use of the functional capabilities of the BRODA chair and ensure that you will quickly become familiar with its use.

If you have any questions about the safe and effective operation of your BRODA chair or accessories after reading this manual, immediately contact your local BRODA representative or our Head Office Customer Service personnel for further assistance.

Head Office:
BRODA Seating
395 Phillip St.
Waterloo, Ontario, Canada
N2L 5R8

Phone: (519) 746-8080 Toll Free Can/US: 1-(800) 668-0637
Fax: (519) 746-8616
E-Mail: sales@brodaseating.com Website: www.brodaseating.com

General Instructions

The instructions contained herein provide guidance on the safe and correct operation of a BRODA chair. Safety measures as described in Section 1 must be observed when operating the chair's functions or moving the chair. Only authorized caregivers should operate or move a chair.

Every person that is involved with the operation and maintenance of the BRODA chair, including the resident's family members, must read this instruction manual prior to moving or operating the functions of this chair. A copy of this instruction manual must always be available to these people. No person, including the resident's family members, who is unfamiliar with or is unwilling or unable to adhere to the safety and operating instructions contained herein, should be permitted to operate or move the chair.

A BRODA chair is designed for use within a Nursing Home, Hospital, or other Long Term Care facility where the potential users benefit from the assistance and care of professional caregivers.

The safety and operating instructions that are included in this manual are very important to the safe and effective operation of the BRODA chair. The resident specific instructions in Section 6 (as determined by the resident's professional caregiver responsible for their seating, from a part of the safety requirements detailed in Section 1) must be followed at all times.

BRODA accepts no liability whatsoever for damage or disruption caused by operating errors, failure to provide proper maintenance, or the disregard of the instructions contained in this manual including the resident specific instructions.

BRODA reserves the right to make changes to the specifications of the dimensions, functions, and components of its products. Any textual or diagrammatic representations provided are not necessarily exactly the same as the delivered products and are not required to obtain spare parts.

Each BRODA chair is provided with a unique, identifying serial number. This serial number should be maintained on the chair and with your equipment records for future reference to obtain spare parts or additional copies of the operating instructions.

1.0 SAFETY REQUIREMENTS

This section must be read by all operators of the BRODA chair before they attempt to use the product. It is the resident's primary caregiver's responsibility to ensure that only people who are familiar with the information contained in this manual are authorized to operate or move the chair.

1.1 Before First Use

BRODA chairs are provided fully assembled and ready to use after purchaser inspection, functional testing, and training requirements have been met. If the chair does not appear to be in ready to use condition upon receipt, immediately contact your supplier and do not put the chair into service until after your concerns have been resolved.

This manual must be read thoroughly by the caregiver(s) directly responsible for the resident's nursing care before the chair is put into service.

The chair must be visually inspected for damage, missing parts, and loose fittings (fasteners) prior to first use or testing the chair's functions. Functional testing must be successfully completed after visual inspection and before first use. These obligations apply both to the first use of the chair and to all subsequent uses. (as described in Section 5, Inspection and Functional Testing)

An in-service on the operation and safety issues, as described in this manual, must be given to the resident's caregivers prior to its first use. (As described in Section 3.0, Caregiver Management)

This manual must be read thoroughly by new caregivers, prior to the first time a new caregiver operates or moves the chair, after the chair has been put into service.

A resident's family members, who share some of the responsibility for a resident's care, may be considered as a caregiver after they have read this manual, received instruction on the chair's safe use by a professional caregiver, and a caregiver directly responsible for the resident's care has given their approval.

1.2 Application

BRODA chairs are intended exclusively for residents of long term care institutions who are under the care of professional caregivers. The Basic Chairs are positioning chairs intended for medium to high level care residents. The suitability and application of a BRODA chair is to be determined by a professional caregiver who is familiar with the seating needs of the resident using the chair. Any other use of the chair is excluded from possible liability claims.

The weight capacity of the Broda Basic Chairs is **660 lbs.** Custom Broda chairs built for bariatric residents, are built with additional gas cylinders and additional strapping to further accommodate the weight in the chair.

The Basic Chairs are not to be used in the shower. Use in the shower may cause the frame or components to rust, and will void the warranty.

The chairs are not explosion resistant and may only be used where there are no flammable gases or liquids present such as anesthetics or petroleum based cleaners.

BRODA chairs are designed for use with specific BRODA accessories and spare parts. Any use of non-BRODA spare parts or accessories with a BRODA chair is excluded from possible liability claims. Any use of BRODA spare parts or accessories on a non-BRODA product is excluded from possible liability claims.

1.3 Legal Restrictions

BRODA chairs may only be used as described in this manual and with proper regard for recognized health care and work place safety and accident prevention practices. BRODA chairs may not be operated or used with non-BRODA spare parts or accessories which could endanger residents, staff, or other third parties. The chair may only be moved or operated by caregivers or family members who can guarantee its correct operation because they have read and fully understood this manual and the safety issues discussed herein.

1.4 Position of Chair “Danger of Falling”

Immediately after a resident is transferred into a chair, we recommend that the chair’s seat be tilted sufficiently to prevent the resident from sliding or falling forward off the chair. The amount of seat tilt used should be determined by the resident’s caregiver who is responsible for seating.

We recommend that the resident’s feet be correctly positioned on the footrests and slightly to fully elevated to prevent the resident from sliding or falling forward off the chair. The amount of elevation used should be determined by the resident’s caregiver who is responsible for seating.

1.5 Position of Seat Tilt “Danger of Tipping”

We recommend that the chair’s seat be tilted sufficiently to prevent an agitated resident from tipping the chair forward or backward, or from slumping and sliding in the chair. The amount of seat tilt used should be determined by the resident’s caregiver who is responsible for seating. Always ensure that the resident is properly positioned before operating the seat tilt.

1.6 Location of Chair “Danger of Tipping or Falling Objects”

We recommend that when a resident has been moved to their destination, the chair is placed where the resident cannot reach handrails or other objects, fixed or movable. This is to prevent the resident from pulling the chair over or pulling themselves off the seating surface and to prevent the resident from pulling movable objects onto the chair and themselves.

We recommend that the chair be used in a supervised area to prevent untrained residents, caregivers, or third parties from unauthorized operation, movement, or unsafe actions such as sitting or leaning on the reclined back, elevated footrest, or the armrests. These actions, if not prevented, put the chair at risk of tipping or damage to the chair.

We recommend that a chair only be located on a level surface to minimize the risk of tipping over.

1.7 Total Lock Wheel Brakes “Danger of Falling”

The special casters found on the BRODA chairs have total lock brakes which prevent the wheels from turning and swiveling. The brakes must always be applied when:

- 1) the chair is not in use;
- 2) a resident is being transferred (moved) into or out of the chair; and,
- 3) the chair is not being moved by a caregiver.

It is important to note that if the wheel locks are applied while the patient is in the chair, that the caregiver does not leave the patient unattended, especially those patients who have the capability or tendency to move the chair and/or those who may be agitated. This could cause harm to the patient if they attempt to move the chair while the wheel locks are applied.

Note: Removing and attaching the footrest may be easier for the caregiver with the brakes applied

Failure to follow these instructions will unnecessarily increase the risk of serious falls by residents, caregivers, or third parties caused by the chair unintentionally moving.

1.8 Re-Positioning of Resident “Danger of Clamping”

BRODA chairs offer the benefits of seat tilt, back recline, legrest/footrest elevation, and moveable arms. During the movement of any of these functions, the following safety measures must be observed:

- 1) The resident’s arms must be positioned inside the chair frame with their hands on their body.
- 2) The resident’s feet must be correctly positioned on the footrests.
- 3) All of the chair’s brakes have been applied.
- 4) Only one caregiver at a time attempts to operate the chair’s functions.
- 5) Only one chair function is operated at a time.
- 6) The rear wheels are in the trailing position, behind the chair frame.
- 7) The residents’ and caregivers’ body are clear of all pinch points before operating the chair’s functions.

Failure to follow these safety measures can put the residents’ or caregivers’ limbs at risk of injury. Residents who may be unaware of their body position or unable to maintain a safe body position are at the most risk of the danger from clamping and caregivers should be more cautious with these residents. A second caregiver may be required to ensure the safety of these residents during these operations.

1.9 Unintended Movement “Danger of Falling or Collision”

We recommend BRODA chairs for indoor use within a long term care institution and where there is not enough slope to cause the chairs to move unaided. Chairs used where the surface is uneven or sloped are at risk of unintended movement and could become a serious danger to the resident, caregiver(s), or a third party. We recommend that BRODA chairs are located away from stairwells, elevators, and exterior doorways within a long term care institution.

Outdoor use is appropriate only under the strict supervision and full attention of a caregiver who is physically capable of preventing any unintended movement over any surfaces that are to be traveled on. We recommend that a second caregiver assist when the chair is moved over surfaces that could cause significant unintended movement.

1.10 Resident Clothing “Risk of Injury to Resident’s Skin”

We recommend that residents only be seated while they are fully dressed in clothing that meets the needs of their specific condition. If after being fully dressed, a resident’s bare arms, legs, or body could still come into direct contact with the vinyl straps or vinyl pads, we recommend the use of a covering, such the BRODA terry cloth covered seat and/or back pad or a folded cloth bed sheet to prevent direct contact. Direct contact of bare skin on the straps over a period of time could cause moisture on the resident, and/or cause the skin to stick to the straps. Prior to the operation or movement of a chair with a covering, the caregiver must ensure any covering placed on the chair does not come into contact with any moving parts and is securely placed, so not to slip.

1.11 Improper Restraint Use “Risk of Serious Injury”

We recommend that alternatives to physical restraints be used with residents while seated in the chair except under the specific instructions of the resident’s primary caregiver and with permission of the resident’s family or guardian. Physical restraints have been identified as a common cause of serious injury to residents while they are seated. We recommend that the primary caregiver responsible for seating first consider the re-positioning options available in the chair to reduce the risks of sliding, falling, or self-injury.

If a physical restraint is determined to be appropriate to prevent sliding or falling out of the chair, we recommend that the BRODA thigh belt be used. If a physical restraint is determined to be appropriate to prevent self-injury from resident movement, we recommend the BRODA HSP padding package. In all cases, it is the resident's primary caregiver that must take responsibility for the safety of the resident if restraints are used.

1.12 Improper Use

The improper use of the chair can be dangerous to the resident, caregivers, or third parties through:

- 1) Unauthorized operation of the chair's functions.
- 2) Unauthorized movement of the chair.
- 3) Inappropriate use of the chair for a resident who has not been assessed by the caregiver responsible for their seating.
- 4) Failure to reposition the resident frequently in the chair
- 5) Attempted simultaneous operation of multiple chair functions by one or more caregivers.
- 6) Attempting to move the chair with the brake(s) applied.
- 7) Leaving the resident unattended in the chair near other objects.
- 8) Leaving a potentially agitated resident in an unsupervised area.
- 9) Leaving a resident unattended for a period of time
- 10) Leaving a resident in a chair on a sloping surface.
- 11) Leaving a chair unattended on a sloping surface.
- 12) Using non-BRODA accessories on the chair.
- 13) Using the BRODA chair at temperatures below 0 Celsius (32 Fahrenheit)
- 14) Using the BRODA chair as a shower or bathing chair.
- 15) Using the BRODA chair for any use other than its intended application

1.13 Cleaning

BRODA chairs should be wiped clean with soap and water. A dilute (four parts water, 1 part bleach) household strength ammonia or chlorine based cleaner, as well as a hospital grade cleaner may be used if necessary. BRODA chairs should not be cleaned with petroleum based cleaners. Any petroleum based products that come in contact with any vinyl surface should be removed as quickly as possible. Petroleum based products make vinyl brittle and will damage the seating surface and cushions. Metal parts and cushions should be wiped completely dry after cleaning. Terry cloth seat and back covers may be laundered and tumble dried. Do not launder vinyl padding.

Do not allow the chair to air dry. Leaving the chair to air dry and not ensuring the chair is completely dry may cause the frame and components to rust. Solvents such as those found in spray lubricants should not be used on BRODA Chairs as they can damage moving parts

BRODA will not accept warranty claims on chairs that have not been cleaned according to the instructions.

Touch up paint is available for the powder coated frame. Please call Broda's Customer Service Department if touch up paint is required. Do not leave BRODA chairs outdoors as the frame is not UV protected. Leaving the chairs outdoors could cause the paint to peel.

1.14 Preventative Maintenance

The maintenance on a BRODA chair will vary with the amount of use and the condition of the resident using the chair. We recommend regular visual inspection for signs of wear, damage, loose or missing fittings, and other safety concerns. Also, periodic testing of the chairs functions is appropriate. If a breakage, defect, or operational problem is detected, the chair must be repaired, inspected and tested for function before it is returned to service. In regular use, after the initial inspection and functional testing, the chair should be inspected and tested on a bimonthly basis. The chair should be inspected and tested as often as each use if the chair is used:

- 1) By aggressive or agitated residents.
- 2) By residents who have involuntary movement.

BRODA Basic Chairs

- 3) On irregular or sloped surfaces.
- 4) By residents weighing over 220 lbs
- 5) By any unauthorized person.

Do not use any lubricants that contain solvents. Solvents will damage many of the moving components in the chair. If necessary a white, food grade grease (lubricant) may be used on the sliding components in the chair.

1.15 Resident Specific Instructions

The professional caregiver responsible for the resident's seating shall add such additional instructions as are necessary for the safety and comfort of the resident using the chair based on their professional experience and knowledge of the resident's specific conditions and requirements. These instructions form a part of the Safety Requirements for using the chair with that resident and must be made available to all caregivers. (see Section 6.0)

2.0 DEFINITIONS and TECHNICAL INFORMATION

2.1 Definitions

"BRODA" means Broda Enterprises Inc. doing business as Broda Seating. BRODA "chair" refers to Basic chair models 30VT and 80V.

"Long Term Care Institution" refers to a Nursing Home, Hospital, or other Health Care facility that provides health and personal care to its residents on a long term basis.

"Resident" refers to an individual living in a Long Term Care Institution under the care of Professional Caregivers.

"Professional Caregiver" refers to the Doctors, Nurses, Therapists, Nurses Aids, Health Care Aids, and other Specialists who work in a Long Term Care Institution and provide health and personal care to its residents.

"Caregiver" refers to any person in a Long Term Care Institution who is appropriately trained to provide care or services to the resident or the chair used by the resident and may include the resident's family members or guardian.

"Seat Tilt" refers to changing the angle of the chair's seat with respect to the chair frame (or ground) without changing the angle between the back and the seat.

"Back Recline" refers to changing the angle between the chair's back and the chair's seat.

"Footrest Elevation" (and legrest elevation) refers to changing the angle between the chair's footrest (and legrest) and the chair's seat.

"Transfer(s)" refers to the movement of a resident into or out of a chair with the assistance of their caregiver(s).

"Mechanical Transfer(s)" refers to the movement of a resident into or out of a chair with the assistance of their caregiver(s) using a patient lift or other assistive device that bears the weight of the resident.

"Safety Requirements" are the important information contained in Section 1 which must be followed to ensure the safe operation of the chair for the resident, caregivers, and third parties.

2.2 Technical Information

Dimensions Based on 20 Inch Basic Chairs

Overall dimensions of the Basic models 30VT and 80V are 50 inches high by 27.5 inches wide by 40 inches long.

BRODA Basic Chairs

The seat width is 20 inches measured between the inside of the arms. The seat depth is 17 inches. The seat height is 20.5 inches measured to the front vinyl strap in the seat. The back length is 32 inches. The back width is 20 inches measured between the wings.

The leg rest is 12 long by 19 inches wide. The removable footrest allows the leg rest to be adjusted to 16, 18, 20 and 22 inches in length.

All dimensions are plus/minus 0.5 inch. Most dimensions can be significantly varied from the above descriptions by adjustments to the chair's arms, vinyl straps, footrests, or cushion positioning (see Section 4, Operation and Movement)

Chair Frame

The frame is all steel construction. The seat, base, back, side panels, arms, wings, legrest, and footrest are powder-coated for durability and corrosion resistance.

Adjustments to the seat tilt, back recline, and independent legrest elevation functions are supported by a mechanical locking device designed to permit controlled movement during the operation of these functions. (See Section 4, Operation and Movement). No motors or other powered devices are used in the chair.

Casters

The Basic Chair has three 5 inch total lock casters and one 5 inch directional lock caster with non-marking grey rubber tires. The casters require minimal maintenance. Lubrication or maintenance may be required in extreme conditions such as steam cleaning, pressure washing or autoclaving.

Arms and Wings

The arms are height adjustable to provide the correct armrest height for the resident's forearms. The arms extend to the front of the seat to aid the resident during transfers.

Removable wings provide upper body lateral support. Adjustable shoulder bolsters that attach to the wings accommodate variances in resident shoulder widths and heights.

Cushions

Standard cushions include: Neckrest Cushion, Shoulder Bolsters, Sole Pad and Lower Side Pads. The 34 ounce healthcare vinyl fabric covering is manufactured to meet the following requirements: DIN 75 200/ DIN 53 438; MVSS 302, M2;CAL 117, and Wyzenbeck Heavy Duty Abrasion Test. Optional removable seat and back pads are covered with an 8 ounce soft vinyl which meets CAN2-162. Pre-shrunk fitted cotton terri covers are provided for the seat and back pads.

2.3 Shipping and Storage Specifications

BRODA chairs should be shipped and stored in an upright position and not stacked higher than 3 boxes. No other materials should be shipped or stored on top of a BRODA box. BRODA boxes should not be placed on pallets.

BRODA chairs should be shipped and stored at temperatures between minus 20 degrees Celsius and plus 40 degrees Celsius. BRODA chairs should not be used until they are between 0 degrees Celsius and 30 degrees Celsius. BRODA chairs should be kept in a clean, dry environment.

Upon receipt, we recommend that the shipping carton be immediately examined for damage. Any damage should be noted on the delivery receipt and a request for inspection by the transportation company should be made. The shipping carton should be opened immediately and the chair examined for concealed shipping damage. If the chair appears to be damaged, a concealed damage report should be immediately filed with the transportation company.

2.4 Labels

BRODA uses certain labels to assist caregivers to identify items which permit the operation of the Basic Chair's functions.

Patent Label (White)

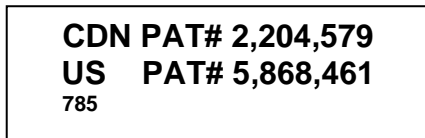

Recline Label (Blue) for Model 30VT



Serial Number Label (Gray)



Footrest Attachment/Detachment Label White

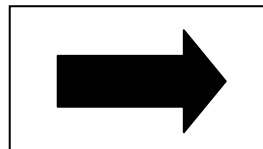

Manufacturers Label (White)



Tilt Label (Tan)



Tilt and Recline Instruction (White) for Model 30VT

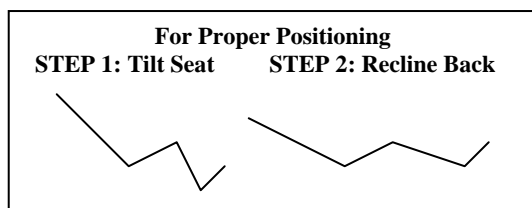

3.0 CAREGIVER MANAGEMENT

BRODA Seating's unique and innovative chairs provide the optimum in re-positioning functions and mobility. However, BRODA's products were designed to be recommended by professional caregivers. The maximum benefit to the resident using this chair will be achieved with the advice and assistance of their caregivers.

The professional caregiver responsible for the resident's seating will add any additional resident specific instructions required for the safe and correct operation of the chair with a specific resident to Section 6.0 at the end of this manual. These additional resident specific instructions shall be considered as important additions to the Safety Requirements in Section 1

At the customer's request, the initial basic training of the resident's caregiver(s) in the operation of the chair will be provided by the local BRODA representative who supplies the chair. The caregiver(s) must adhere to the Safety Requirements at all times to ensure the safety of the resident, caregivers, and third parties.

The customer will maintain a list of caregivers who have read this manual and are authorized by them to operate and move the chair.

BRODA assumes no liability for damage, injury or accidents caused by careless, negligent, incorrect, or unauthorized operation or movement of its chairs.

4.0 OPERATION and MOVEMENT

Safety measures as described in Section 1 must be observed when operating the chair's functions or moving the chair. Only authorized caregivers should attempt to operate or move a chair. The caregiver must use proper body mechanics when operating the chair, and be prepared to support the weight of the resident while operating the chair.

4.1 Seat Tilt

The seat can be tilted to any position from the most upright to the lowest within its range. This assists the caregiver in changing a resident's body position to minimize slumping, falling or sliding forward. The tilt can also increase the stability of the chair to minimize the risk of tipping over and improve the resident's comfort. The 30VT and 80V have up to 25° of tilt range.

To Activate the Seat Tilt:

- Locate the tilt handle on the left side of the chair (**figure 1.0**)
- Place your right hand on the bar to assist movement and squeeze the tilt handle with your left hand (**figure 1.1**)
- Raise or lower seat tilt until desired angle is achieved.
- Release the handle once the seat is in the desired position

Note: The ease of changing seat tilt may be affected by the weight of the person in the chair, or if the chair is unoccupied.

4.2 Back Recline

The back can be reclined to any position from the most upright to the lowest within its range. This assists the caregiver in changing a resident's body position to: improve the resident's comfort and/or to assist caregivers in providing daily care activities. The 30VT has up to 45° of recline range. The 80V does not recline.

Note: Always tilt slightly before reclining to prevent patient from sliding

To Activate Back Recline:

- Locate the recline handle on the right side of the chair (blue label) (**figure 1.2**)
- Place your left hand on bar to assist movement and squeeze the recline handle with right hand (**figure 1.3**)
- Raise or recline the back until desired angle is achieved.

-Release the handle once the back is in the desired position.

Note: Do not operate the tilt and recline handles together.

Standard Position



Tilt Position



Figure 1.0 Tilt Handle



Figure 1.1

Recline Position (applies to 30VT only)



Figure 1.2 Recline Handle

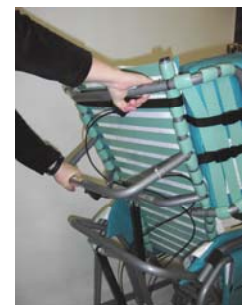

Figure 1.3

4.3 Elevating Leg rest

The leg rest elevates with the back recline on the 30VT. This eliminates the need for elevating the leg rest after reclining the resident in the chair. The Basic Chair leg rest can also be operated independently and is adjustable anywhere between vertical and horizontal. When the seat is tilted, the leg rest can be raised beyond vertical to become parallel with the seat angle.

To Adjust the Leg Rest Independently of the Back Recline:

- Locate the leg rest handle on the lower side of the chair (right side when facing the front of the chair) (**figure 1.4**)
- Hold the leg rest with your left hand and squeeze the handle with your right hand (**figure 1.5**)
- With your left hand, raise or lower the leg rest to the desired angle.
- Release the handle for leg rest to remain in desired position

Note: The leg rest articulates with changes to the back recline but not with changes to the seat tilt. If the back is in the reclined position, the leg cannot be lowered independently

Elevated Legrest



Figure 1.4

Legrest Handle



Figure 1.5

4.4 Flip Down Footrest

The Flip Down Footrest is detachable and length adjustable. It allows for access to the seat surface without removing the footrest. The footrest allows the length of the legrest to be adjusted to 16", 18", 20" and 22".

To Attach the Footrest to the Leg Rest:

The footrest should be attached to the leg rest at the location, which provides correct foot support for the resident as determined by the caregiver. If a mechanical transfer is used by the caregiver, the footrest should be left in a flipped down position.

- Locate the holes on the inside of the leg rest frame between the leg rest straps (**figure 1.6**)
- Insert the right end of the upper cross piece of the footrest into the desired hole on the leg rest. Push the footrest to the right to activate the spring mechanism in the cross piece of the footrest (**figure 1.7**)
- Line up the left end of the cross piece with the corresponding hole on the left side of the leg rest (**figure 1.8**)
- Release the tension on the spring mechanism. The left end of the cross piece will enter the hole.

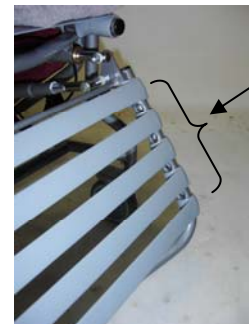

Holes for Footrest length adjustment (Increments between straps)

Figure 1.6



Figure 1.7



Figure 1.8



Footrest Attached

To Remove the Footrest From the Leg Rest:

-Lift the bottom end of the footrest slightly to discontinue contact between the straps on the foot rest and the straps on the leg rest

-Squeeze the footrest to the right, to activate the spring mechanism. (figure 1.9)

-Remove the left end of the cross piece from the hole on the left side of the leg rest. (figure 2.0)

-Remove the right end of the cross piece from the hole on the right side of the leg rest and remove the footrest.



Figure 1.9



Figure 2.0

To Operate the Optional Split Flip Down Footrest

The footrest may be flipped up to provide easier access to the front of the chair by residents during transfers.

-When seating the resident, make sure both footplates are upright and the leg rest is vertical

-Once the user is on the seat surface, from the left side of the chair reach across the legs with your left hand. Pull the left leg towards you. (figure 2.1)

-Flip down the footplate with your right hand (figure 2.2)

-Place both feet on the flipped down footplate. Flip down the second footplate (figure 2.3)

- Place both feet on the appropriate foot plate (figure 2.4)

-Reverse this process when exiting the chair.



Figure 2.1



Figure 2.2



Figure 2.3



Figure 2.4

To Adjust the Footplate Angle (Optional Split Flip Down Footrest)

The footplates adjust independently, and are infinitely adjustable within their range. They can each be set at angles less than 90 degrees to accommodate ankle contractures. As well, they can be adjusted to greater than 90 degrees to accommodate foot drop (figure 2.5)

The footplates can be adjusted simply by moving them up or down. It is also possible to set the footplates in a fixed position by adjusting the bolts

-Locate the set of bolts on the rear of the footrest. These bolts are adjusted individually.

- To make the angle of the footplate less than 90 degrees, extend the bolt (as indicated at A) To make the angle more than 90 degrees, shorten the bolt (as indicated by B)

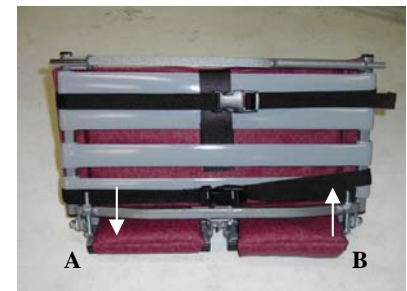

Figure 2.5

4.5 Removable Wings

Wings support the shoulder bolsters which provide upper body lateral support to the resident.

To Remove the Wings

-Depress the top button found beside the wing on the chair back (figure 2.6)

-While depressing the button, pull the top of the wing frame from the receptacle. The wing may now be moved out of the way without its full removal. (figure 2.7)

-To completely remove the wing, depress the button on the lower portion of the wing frame and remove from the receptacle

To Replace the Wing Frame

- Insert the lower end of the wing into the lower receptacle first. Then insert the upper end into the upper receptacle



Figure 2.6



Figure 2.7



Wing Removed

4.6 Shoulder Bolsters

The Shoulder Bolsters provide upper torso support, protection and containment. Individually adjustable, they accommodate asymmetries in the chair user. Their unique design allows for proper elbow access to the arm rest. The Shoulder Bolster is always used in conjunction with the side wing.

To Attach the Shoulder Bolsters

The Shoulder Bolster attaches to the wing by two straps with snap buckles.

-Feed both Shoulder Bolster straps between the inner strap of the wing and the frame of the chair.

-The upper strap is pulled around the outside of the wing frame and the lower strap is fed between the outside strap of the wing and the frame of the wing. (figure 2.8)

-Snap the buckles together and cinch the strap to secure the bolster to the wing. The bolster can be slid up and down the wing if desired. (figure 2.9)

-To lock the bolster in place, feed the upper strap around the frame of the chair back. The bolster can no longer be vertically adjusted. The top strap must be unbuckled to remove the wing from the chair.

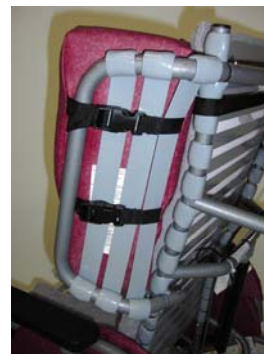

Figure 2.8



Figure 2.9

Note: The Shoulder Bolster can be inverted on the wing in order to provide support to the lower torso and to those with a narrow upper torso. Place the bolster upside down on the wing frame and attach as described above.

4.7 Height Adjustable Armrests

The height adjustable armrests are raised or lowered using a 5/32" Allen wrench to loosen set screws on the armrest. The arms are adjustable within approximately a 6" range.

- Lift up the flap on the outside panel exposing the armrest height adjustment set screws (**figure 3.0**)
- Using a 5/32" Allen wrench, loosen, but do not remove the screws
- Raise or lower the armrest to the desired height and tighten the adjustment bolts (**figure 3.1**)
- Secure the outside flap on the side panel. Change the height of the other arm as desired.



Figure 3.0



Figure 3.1

4.8 Adjustable Seat Height

The Basic Chairs have an adjustable seat height. The Basic Chair Base can be used as a Pedal Chair base for residents who are approximately 6'2" and over. The seat height increments on the Basic Chair are 19.5", 20.5" and 21.5". The proper seat height should be determined by the resident's professional caregiver.

- Locate the seat height adjustment bolts on either side of the front of the chair frame (**figure 3.2**)
- Using 7/16" wrenches, remove the bolts
- Raise or lower the front of the seat to correspond with the holes at the desired seat height.
- Insert the bolts through the desired corresponding holes and tighten
Note: Do not perform seat height adjustments while the chair is occupied



Figure 3.2

Seat height adjustments

4.9 Casters

The Basic Chair has three 5 inch total lock swivel casters and one 5 inch directional locking rear caster

Total lock casters:

- Step on the pedal to lock the casters into place (**figure 3.3**)
- Step off the pedal to unlock the caster (**figure 3.4**)

Note: Always ensure the brakes are unlocked when moving the chair



Figure 3.3



Figure 3.4

Directional Locking Caster:

When the pedal is applied, the directional locking caster eliminates any swivel function, allowing the chair to easily be moved straight down hallways or aisles.

- Step on the pedal to lock the casters into place (**figure 3.5**)
- Step off the pedal to unlock the caster (**figure 3.6**)



Figure 3.5



Figure 3.6

4.10 Accessories (Options)

We recommend BRODA accessories for use only on BRODA chairs. The correct installation of the BRODA accessory is very important. We recommend that the BRODA chair is ordered with the required accessories already installed. Only authorized caregivers who thoroughly understand the accessory installation procedures should attempt to install their BRODA accessories without assistance from their local BRODA representative. BRODA does not recommend use of other manufacturer's accessories on BRODA chairs.

4.11 BRODA Tray



Grey Tray



Clear Tray

The optional BRODA tray is specially designed to work with your BRODA chair. Made of a single piece of durable ABS plastic, the tray securely slides over the arms of the chair to provide a level surface for meals or activities. A BRODA strap may be used to prevent the resident from accidentally pushing the tray off the chair. The strap should be buckled together behind the chair back below the armrests and as close to the level of the chair seat as possible. A tray strap with a side buckle is also available to meet non-restraining policies

Note: The BRODA tray is not to be used as a restraint. Using the tray as a restraint may cause harm to the resident, caregiver or third party.

Note: When inserting tray on to chair, ensure that residents' and caregivers' body are clear from pinch points to allow safe insertion of tray

4.12 BRODA Thigh Belt

The optional BRODA Thigh Belt is a one piece positioning device used for pelvic positioning. It leaves the hips and upper torso completely unrestrained. There is no danger of the patient sliding under the belt as with standard lap belts. The Thigh Belt should only be used if recommended by the resident's primary caregiver and the resident's family or guardian gives permission.

To attach the Thigh Belt:

- Locate the front cross piece of the seat frame (under the strapping)
- Starting from under the chair seat, pass one end of the thigh belt between the second and third strap from the front of the seat (**figure 3.7**)



Figure 3.7



Figure 3.8

- Pass the other end of the Thigh Belt through the same place in the chair seat. Ensure that the center strap of the Thigh Belt is looped around the front cross piece of the seat frame (**figure 3.8**)

-One padded section of the Thigh Belt passes over each thigh. Connect the snap buckles behind the chair. **Do not fasten around the cylinder or cable behind the chair.** Tighten the straps as necessary (**figure 3.9**)



Figure 3.9

Note: Use caution when reclining a resident who is using a Thigh Belt. It may pull on the thighs if fastened too tight. It may need to be loosened for reclining.

Any excess belt material should be tightened sufficiently to prevent unwanted movement of the belt but with caution to ensure resident comfort is not compromised. Excess belt material may also be tucked away, so as to not get pulled. If the caregiver is unsure about the correct installation or operation of the BRODA Thigh Belt, the caregiver should contact their local BRODA representative for assistance before using this accessory.

4.13 BRODA HSP Padding Package

The BRODA HSP Padding Package includes the BRODA thigh belt, which may only be used if recommended by the resident's primary caregiver and permission is given by the residents' family or guardian. The instructions in Section 4.12 must be followed when using a BRODA thigh belt.

The BRODA HSP Padding Package is designed for residents who are agitated or have involuntary movements. To minimize resident contact with the chair frame, this accessory package includes: a Full-Extended Footpad, a Fixed Frame Footrest, Extended Shoulder Bolsters, Wing Covers and Thigh Belt.

5.0 INSPECTION and FUNCTIONAL TESTING

Safety measures as described in Section 1 must be observed when inspecting or testing a chair. Only authorized caregivers or maintenance staff should attempt to inspect or test a chair.

5.1 Inspection

We recommend regular visual inspection for signs of wear, damage, loose or missing fittings, and other safety concerns. If a breakage, defect, or operational problem is detected, the chair must be repaired inspected and tested for function before it is returned to service.

We recommend that the chair be inspected as often as each use if there is any reason to be concerned about the possibility of increased wear or loose or missing fittings. **At a minimum, in regular use the chair should be inspected on a bimonthly basis.** The visual inspection procedure should include at least the observation of the following fittings (fasteners):

- 1) The bolts which attach the rear casters to the chair base.
- 2) The two bolts and two nuts which attach the front casters to the chair base.
- 3) The nuts and bolts that attach the cylinders that position the seat tilt, back recline, and independent legrest elevation.
- 4) The two bolts and two nuts which attach the chair back to the rods the leg rest is attached to.
- 5) The two sets of two bolts and two nuts which attach the steel seat tilt rods to the chair base.
- 6) The two bolts and two nuts which attach the chair back to the chair seat
- 7) The two bolts and two nuts which attach the leg rest to the rods at the front of the chair
- 8) Each of the nuts and bolts on the footrest, especially those used for the adjustable footplates

The visual inspection procedure should include at least the observation of the following parts:

- 1) The cylinders that position the seat tilt, back recline, and independent legrest elevation.
- 2) The vinyl straps used in the seat, back, legrest, footrest and wings
- 3) The cushions
- 4) The black handles and cables.
- 5) The armrest height adjustment pins

We recommend the visual inspection procedure should include the observation of any installed accessories as described in Section 4.10 to 4.13.

5.2 Functional Testing

We recommend that the chair should be tested for operation of the chair's functions without a resident in the chair. The testing may be as often as each use if there is any reason to be concerned about the possibility of increased wear or damage to the chair's components. At a minimum, in regular use the chair should be tested for functions as described in Sections 4.1 to 4.9.

If the caregiver or maintenance department performing the functional testing believes that any function is not operating correctly, the chair should be taken out of service until a satisfactory functional test can be completed.

The caregiver or maintenance department performing the testing should be aware that the seat tilt, back recline, and footrest (legrest) elevation operations will be more difficult without a resident in the chair.

When performing repairs or maintenance, do not use lubricants that contain solvents. Solvents will damage many of the moving components in the chair. If necessary, a white, food grade grease (lubricant) may be used on the sliding components in the chair. Do not use spray lubricants on any part of the chair.

7.0 REPAIR AND MAINTENANCE

Please have the chair serial number ready when contacting Broda or your local area representative for parts or assistance for your chair. The serial number can be found on a grey sticker on the rear of the chair.

7.1 Trouble Shooting for Cylinders

Gas Cylinders

The use of gas charged springs on Broda products allow the caregiver to easily make adjustments to the tilt, recline, and leg rest with a minimum amount of effort. The gas cylinders contain Nitrogen gas, it is not flammable nor is it toxic. The cylinders provide a lifting force of 300 Newtons (approx. 68 Lbs). In other words the cylinders reduce the amount of weight the care giver has to lift by 68Lbs.

How do they work?

On the end of the stem of the cylinder is a small pin. When the operator depresses the handle, this pulls on the cable which in turn pulls on a small lever inside the actuator mechanism into which the stem of the cylinder is mounted. This depresses the pin, which in turn opens a valve located inside the barrel of the cylinder. This allows for changes in position. When the operator releases the handle the valve closes and locks the cylinder in the desired position.

Over the years Broda has used many different types of actuators to operate the gas cylinders used on our products. Although they may look different their function is one and the same (to push against the pin and open the valve that controls the cylinder). If the cylinder is not properly adjusted when mounted in the actuator, the cylinder may not function properly.

Maintenance

The gas cylinders do not require any maintenance, although they may need to be adjusted due to wide temperature variations or cable stretch.

When adjusting the cylinder it is important that you do not damage the stem on the cylinder. Small scratches left by applying the jaws of pliers or Vice Grips directly to the shaft while making adjustments will destroy the seal and allow the gas inside the cylinder to escape. Use a piece of vinyl strapping or rubber to protect the cylinder shaft from the jaws of the tool you are using to make the adjustments.

Trouble shooting:

Often when experiencing problems with cylinders on Broda chairs, the cylinder is not damaged, it just needs adjustment. There are two common adjustments.

- 1. The pin that the cable handle pulls on at the end of the cylinder is not connected correctly.**
- 2. Or the handle or cable assembly have become broken or disconnected.**

The cable mechanism works exactly like a bicycle brake and is easy to check when experiencing problems.

Other solutions to common problems are listed below.

1. **Chair is not reclining or tilting when cylinder handle is pulled.**
 - a. The pin in the end of the cylinder is not being depressed when the handle is pulled.
Action to take: See adjustment steps
2. **The chair seems to slowly slide out of position**
 - a. The pin in the end of the cylinder may be still partially depressed.
Action to take: See adjustment steps.

Adjustment Steps



Note: Cylinder does not need to be removed from the chair to make this adjustment.

1. Loosen the lock nut located on the stem of the gas cylinder next to the actuator (17mm or 11/16" wrench).
2. From the above instruction determine whether you want to wind the stem further into the actuator or further out of the actuator. **You will need to wind the stem further into the actuator if the chair is not tilting or reclining, (wind it clockwise) and wind it further out of the actuator if the chair is slowly sliding out of position. (wind it counter-clockwise)**



Note: When adjusting cylinders with tools that come in contact with the cylinder rods. A cloth, piece of vinyl strap, or some other protective material must be used to protect the sliding surface of the rod. If the rod becomes scratched or scarred it will puncture the seal on the cylinder and the cylinder will fail.

Damaging a cylinder in this fashion voids the manufacturer's warranty.

3. Wind the stem in the correct direction one half turn. When viewing the cylinder with stem pointing towards you turn the stem clockwise to wind the stem out of the actuator and counter-clockwise to wind the stem into the actuator.
4. Check the function of the cylinder and repeat steps 3 & 4 until the cylinder functions properly.
5. Tighten the lock nut loosened in step 1.

If adjusting the cylinder does not correct the problem, the cylinder may need to be replaced. Please contact Broda at 1-800-668-0637 or your local area representative.

7.2 Cables and Handles

Maintenance

The cables and handles do not require any maintenance.

Removal and Installation

The cable is used in conjunction with a cable handle and an actuator to control the function of the gas cylinder. The cable and handle are one unit. On the actuator end, the cable hooks into the lever that

BRODA Basic Chairs

depresses the control pin on the cylinder. The cable housing either clips into the actuator housing or is held in place by a cable tie.

Steps:



1. Unclip the cable from the actuator.



2. Cut the cable ties that secure the cable to the frame of the chair (carefully note the location of the cable ties and how the cable is threaded around the frame of the chair.)



3. Remove the mounting screw



4. Remount the new handle assembly to the frame of the chair using the screw removed in step 3.



5. Thread the new cable around the frame of the chair the same as the old one and install new cable ties where necessary.



6. Hook the end of the cable into the lever in the actuator and clip the cable housing into the actuator housing.



7. Install a new cable tie around the end of the cable housing and the actuator, if the chair was originally equipped with one.

Note: This procedure may vary on earlier models.

7.3 Vinyl Strapping

Maintenance

The only maintenance required for the vinyl straps is general cleaning with ammonia or chlorine based cleaners (Do Not use petroleum based cleaners).

Installation/Replacement Instructions

The vinyl strapping has both elasticity and memory retention this allows each strap to conform to the resident as an independent unit. Occasionally a strap may lose memory or be cut. This makes it necessary to replace them. These straps are installed under tension this is done by heating the straps so that they are soft and pliable and this enables them to be easily stretched during installation. They are held in place by riveting them to the steel frame of the chair and then wrapping them around the frame over the top of the rivet. This is done the same for both ends of the strap.

Steps: (see following page for illustration)

- 1) Remove the old strap by cutting it in two and drilling out the rivets with a 3/16" drill bit.
- 2) Heat the strap either by placing it in a pot of boiling water for a couple of minutes or by laying it out and heating it with a heat gun.

BRODA Basic Chairs

- 3) Rivet one end of the strap with a 3/16" diameter 3/8" long rivet, through the precut hole in the end of the strap to the frame with the crowned side of the strap up (shiny side).
- 4) Wrap the strap around the frame, over the top of the rivet.
- 5) Stretch the strap and wrap it around the other side of the frame next the rivet hole (do not cover the rivet hole with the strap).
- 6) Rivet the other end of the strap, through the precut hole in the end of the strap to the frame.
- 7) Stretch the strap and move the offset strap over to cover the rivet.

Note: If the strap cools off during the installation you can reheat it with a heat gun.

Vinyl Strap Installation:

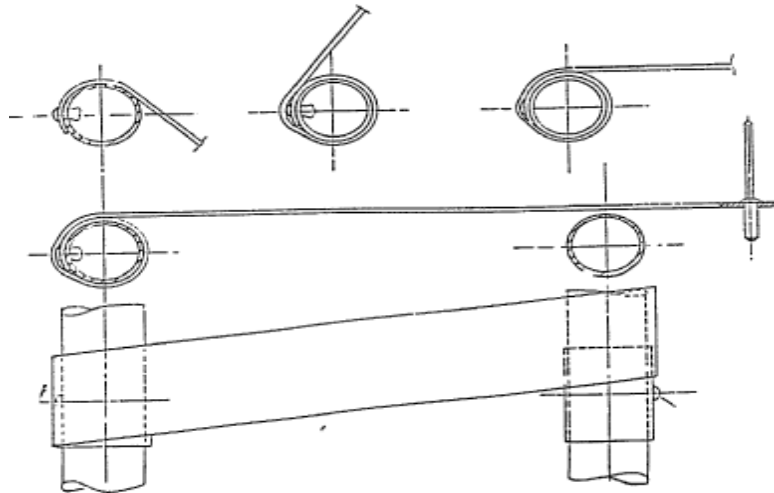

8.0

BRODA SEATING WARRANTY

BRODA provides a Three Year Warranty on the chair frame, and a One Year Warranty on all other components subject to the following conditions:

No warranty is provided on seat pads or cloth covers.

The chair frames are guaranteed for three years against structural defects or failure. All other parts (except seat pads and cloth covers) including but not limited to strapping, cushions, gas springs and attachments, casters, wheels, brakes and armrests are guaranteed for one year against defects in materials and workmanship based on normal institutional use. The guarantee does not cover malicious or deliberate damage or damage from misuse. The guarantee does not cover use of Broda chairs in a shower or pool, with the exception of the Broda Commode/Shower Chair.

Modifications to Broda products or the use of non-Broda supplied parts voids the warranty. This warranty does not cover shipping damage (see below).

BRODA will provide new or refurbished parts for installation by the owner at no cost following confirmation by the local BRODA Representative or the BRODA Head Office Customer Service Representative. On request, defective parts must be returned to the factory within thirty days of receipt of the replacement parts by the owner. If the defective parts are not returned to BRODA on request, the owner will bear the cost of the replacement parts on invoice from BRODA.

Warranty does not include on-site labor for the installation of warranty parts or warranty repairs. The owner may return to BRODA products for warranty replacement or repair by shipping items prepaid and insured to the factory. Warranty completed at the factory includes both materials and labor. Parts to be repaired or replaced at the discretion of BRODA. All returns to the factory require prior authorization from BRODA.

BRODA retains the right to make design and application changes without notice. All orders will be filled with BRODA's current models unless otherwise specified by the purchaser.

BRODA chairs are designed for patient mobility, positioning, and comfort in specialty seating, however, the application of BRODA products shall remain the responsibility of the purchaser or user.

This warranty is not transferable.

RETURNS

BRODA Seating will not accept any returns without a prior **Returned Goods Authorization Number**. Please contact our Head Office Customer Service Representative at 1-800-668-0637 for assistance. Returns must be insured when shipped.

DAMAGED FREIGHT

NOTIFY THE CARRIER OF ANY DAMAGE IMMEDIATELY

It is the responsibility of the person receiving the goods to examine cartons and goods before accepting receipt. Note all damages on the bill of lading and file a claim if necessary. Notify the carrier of any concealed damaged within a maximum of 48 hours.

BRODA insures all products for intransit damage, failure to notify the carrier of intransit damage voids both the insurance and the BRODA warranty. If you require assistance, please contact our Head Office at 1-800-668-0637.

SALES TAX

Most Broda products are G.S.T. Zero Rated and Exempt from Canadian Provincial Sales Tax. Purchasers may be required to check with their Provincial or State Tax Office for purchaser tax payment.